

Matched Pairs of Emitters and Detectors

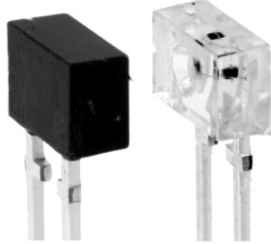

96 12317_1

DESCRIPTION

The TCZT8020 include matched infrared emitters and phototransistors in leaded packages, used to assemble custom-designed transmissive sensors or reflective sensors. The phototransistor package blocks visible light.

FEATURES

- Package type: leaded
- Detector type: phototransistor
- Dimensions (L x W x H in mm): 4.4 x 2 x 3
- Typical output current under test: $I_C = 0.5 \text{ mA}$
- Daylight blocking filter
- Emitter wavelength: 950 nm
- Angle of half intensity: $\varphi = \pm 25^\circ$
- S420P: single detector component
- V420P: single emitter component
- Lead (Pb)-free soldering released
- Compliant to RoHS directive 2002/95/EC and in accordance to WEEE 2002/96/EC

RoHS
COMPLIANT

APPLICATIONS

- Custom-design sensors for various distances
- Reflective sensors
- Transmissive sensors

PRODUCT SUMMARY

PART NUMBER	GAP WIDTH (mm)	TYPICAL OUTPUT CURRENT UNDER TEST ⁽¹⁾ (mA)	DAYLIGHT BLOCKING FILTER INTEGRATED
TCZT8020	Variable	0.5	Yes

Note

⁽¹⁾ Conditions like in table basic characteristics/coupler

ORDERING INFORMATION

ORDERING CODE	PACKAGING	VOLUME ⁽¹⁾	REMARKS
TCZT8020	Bulk	MOQ: 2000 pairs, 1000 pcs/bulk	Detectors and emitters in separate bulk

Note

⁽¹⁾ MOQ: minimum order quantity

ABSOLUTE MAXIMUM RATINGS ⁽¹⁾

PARAMETER	TEST CONDITION	SYMBOL	VALUE	UNIT
COUPLER				
Ambient temperature range		T_{amb}	- 55 to + 85	°C
Storage temperature range		T_{stg}	- 55 to + 100	°C
Soldering temperature	Distance to package 2 mm, $t \leq 5 \text{ s}$	T_{sd}	260	°C
INPUT (EMITTER)				
Reverse voltage		V_R	6	V
Forward current		I_F	60	mA
Forward surge current	$t \leq 10 \mu\text{s}$	I_{FSM}	1	A
Power dissipation	$T_{amb} \leq 25 \text{ }^\circ\text{C}$	P_V	100	mW
Junction temperature		T_j	100	°C
OUTPUT (DETECTOR)				
Collector emitter voltage		V_{CEO}	70	V
Emitter collector voltage		V_{ECO}	7	V

ABSOLUTE MAXIMUM RATINGS (1)				
PARAMETER	TEST CONDITION	SYMBOL	VALUE	UNIT
OUTPUT (DETECTOR)				
Collector current		I_C	50	mA
Collector peak current	$t_p/T = 0.5, t \leq 10 \text{ ms}$	I_{CM}	100	mA
Power dissipation	$T_{amb} \leq 25 \text{ }^\circ\text{C}$	P_V	150	mW
Junction temperature		T_j	100	$^\circ\text{C}$

Note

(1) $T_{amb} = 25 \text{ }^\circ\text{C}$, unless otherwise specified

ABSOLUTE MAXIMUM RATINGS

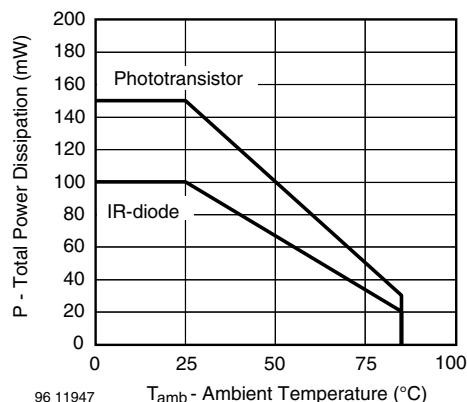

Fig. 1 - Power Dissipation Limit vs. Ambient Temperature

BASIC CHARACTERISTICS (1)						
PARAMETER	TEST CONDITION	SYMBOL	MIN.	TYP.	MAX.	UNIT
COUPLER						
Collector current	$V_{CE} = 5 \text{ V}, I_F = 20 \text{ mA}, d = 4 \text{ mm}^{(2)}$	I_C	0.25	0.5		mA
I_C/I_F	$V_{CE} = 5 \text{ V}, I_F = 20 \text{ mA}, d = 4 \text{ mm}$	CTR	1.25	2.5		%
Collector emitter saturation voltage	$I_F = 20 \text{ mA}, I_C = 25 \text{ } \mu\text{A}$	V_{CEsat}			0.4	V
Cut-off frequency	$I_F = 10 \text{ mA}, V_{CE} = 5 \text{ V}, R_L = 100 \text{ } \Omega$	f_C		110		kHz
INPUT (EMITTER)						
Forward voltage	$I_F = 50 \text{ mA}$	V_F		1.25	1.6	V
Radiant intensity	$I_F = 60 \text{ mA}, t_p = 20 \text{ ms}$	I_e			7.8	mW/sr
Peak wavelength	$I_F = 100 \text{ mA}$	λ_p	940			nm
Virtual source diameter	DIN EN ISO 1146/1:2005	d		1.1		mm
OUTPUT (DETECTOR)						
Collector emitter voltage	$I_C = 1 \text{ mA}$	V_{CEO}	70			V
Emitter collector voltage	$I_E = 100 \text{ } \mu\text{A}$	V_{ECO}	7			V
Collector dark current	$V_{CE} = 25 \text{ V}, I_F = 0 \text{ A}, E = 0 \text{ lx}$	I_{CEO}			100	nA
SWITCHING CHARACTERISTICS						
Turn-on time	$V_S = 5 \text{ V}, I_C = 1 \text{ mA}, R_L = 100 \text{ } \Omega$ (see figure 10)	t_{on}		15		μs
Turn-off time	$V_S = 5 \text{ V}, I_C = 1 \text{ mA}, R_L = 100 \text{ } \Omega$ (see figure 10)	t_{off}		10		μs

Note

(1) $T_{amb} = 25 \text{ }^\circ\text{C}$, unless otherwise specified

(2) Characteristics are measurement with $d = 4 \text{ mm}$ (0.55") distance between emitter and detector, within a common axis of 0.5 mm (0.02") and with parallel alignment within 5°

BASIC CHARACTERISTICS

$T_{amb} = 25\text{ }^{\circ}\text{C}$, unless otherwise specified

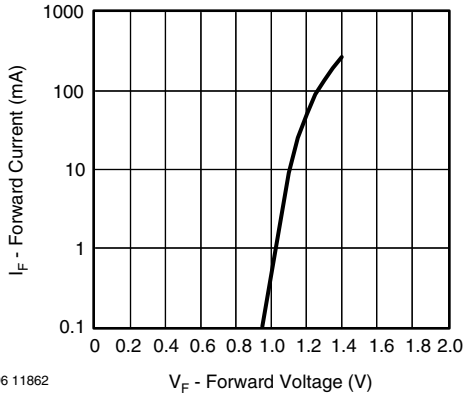

Fig. 2 - Forward Current vs. Forward Voltage

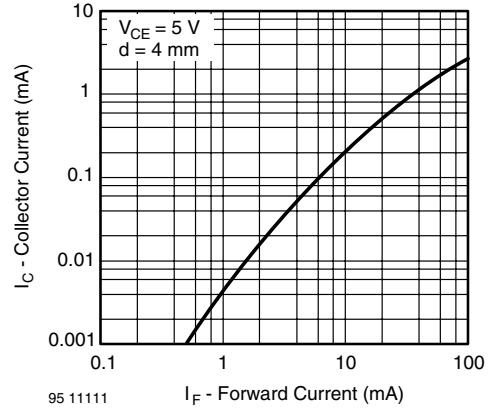

Fig. 5 - Collector Current vs. Forward Current

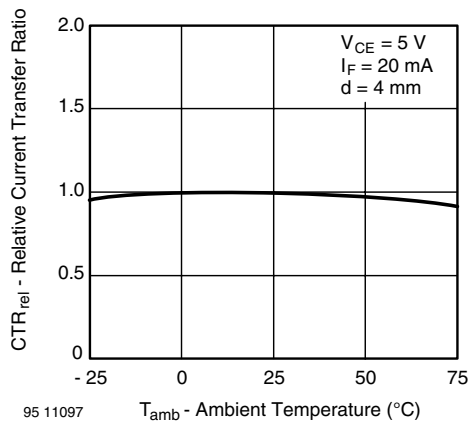

Fig. 3 - Relative Current Transfer Ratio vs. Ambient Temperature

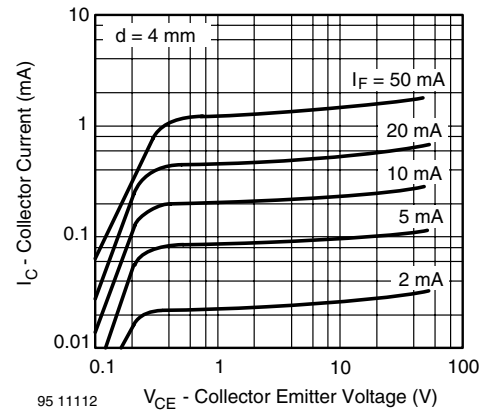

Fig. 6 - Collector Current vs. Collector Emitter Voltage

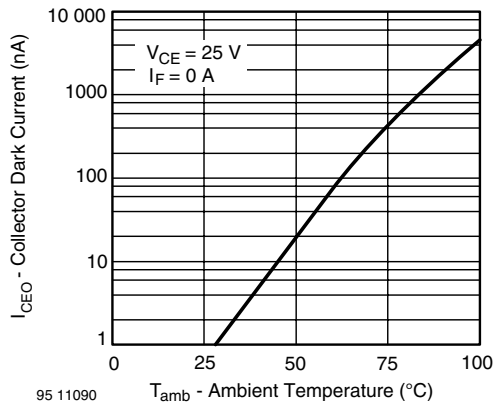

Fig. 4 - Collector Dark Current vs. Ambient Temperature

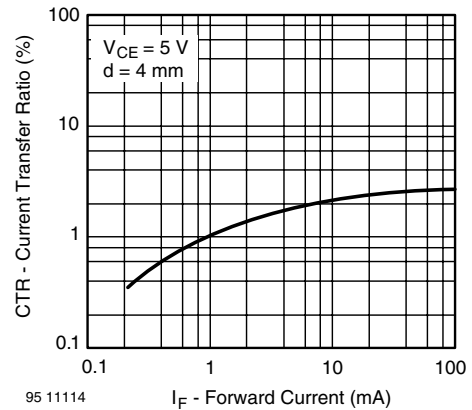

Fig. 7 - Current Transfer Ratio vs. Forward Current

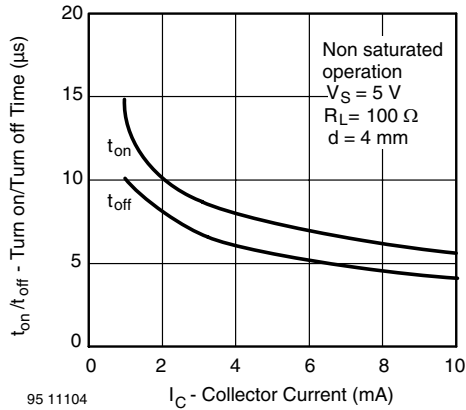

Fig. 8 - Turn on/off Time vs. Forward Current

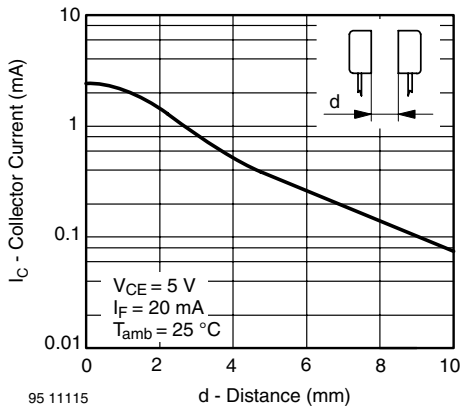

Fig. 9 - Collector Current vs. Distance

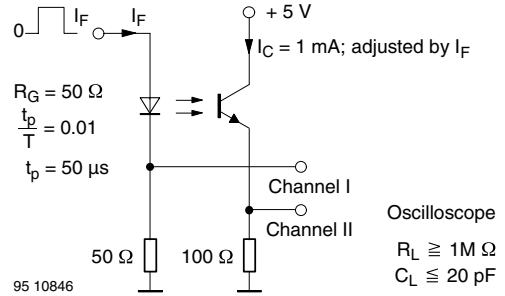

Fig. 10 - Pulse Diagram

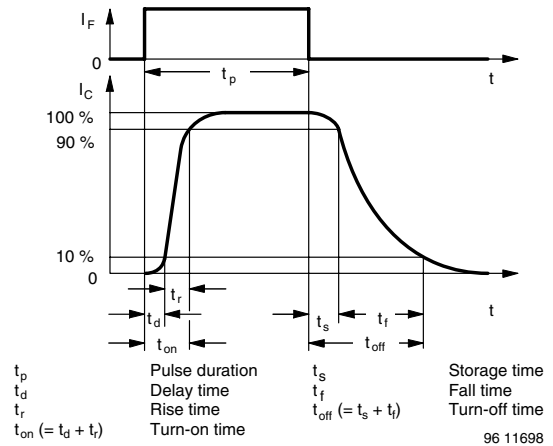
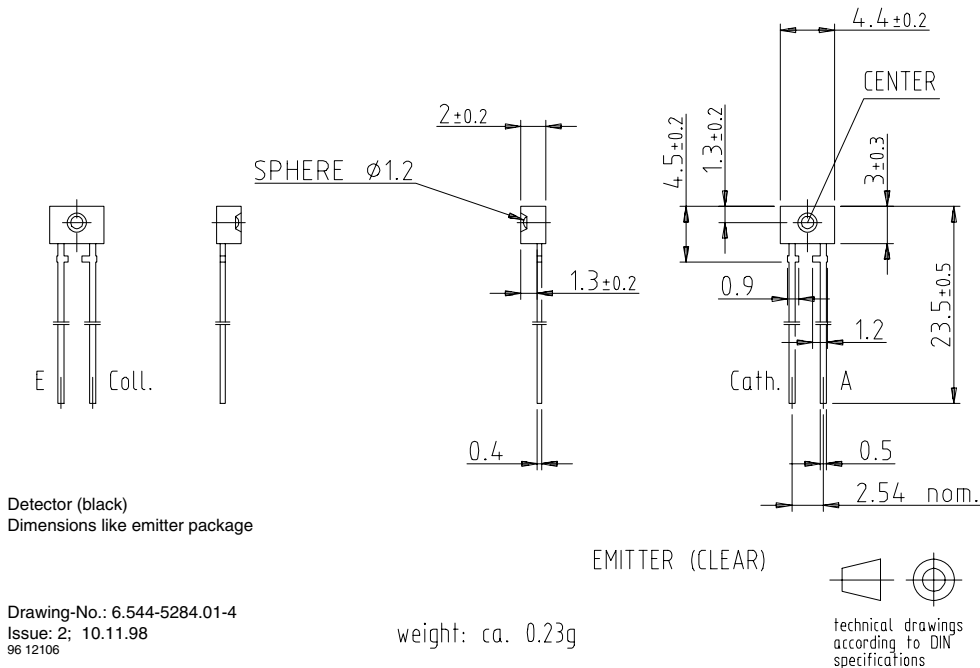

Fig. 11 - Switching Times

PACKAGE DIMENSIONS in millimeters





Disclaimer

All product specifications and data are subject to change without notice.

Vishay Intertechnology, Inc., its affiliates, agents, and employees, and all persons acting on its or their behalf (collectively, "Vishay"), disclaim any and all liability for any errors, inaccuracies or incompleteness contained herein or in any other disclosure relating to any product.

Vishay disclaims any and all liability arising out of the use or application of any product described herein or of any information provided herein to the maximum extent permitted by law. The product specifications do not expand or otherwise modify Vishay's terms and conditions of purchase, including but not limited to the warranty expressed therein, which apply to these products.

No license, express or implied, by estoppel or otherwise, to any intellectual property rights is granted by this document or by any conduct of Vishay.

The products shown herein are not designed for use in medical, life-saving, or life-sustaining applications unless otherwise expressly indicated. Customers using or selling Vishay products not expressly indicated for use in such applications do so entirely at their own risk and agree to fully indemnify Vishay for any damages arising or resulting from such use or sale. Please contact authorized Vishay personnel to obtain written terms and conditions regarding products designed for such applications.

Product names and markings noted herein may be trademarks of their respective owners.